

# SAIGON



## VITRINE POISSONS SUR PIEDS

Double froid - Evaporateur traité par cataphorèse

Réalisé en inox AISI 316 adapté aux milieux salins

### NIVEAU DE FABRICATION



### NIVEAU DE PERSONNALISATION

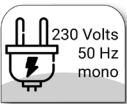
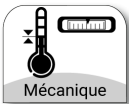
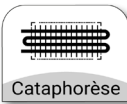
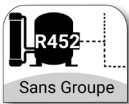
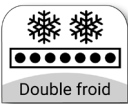
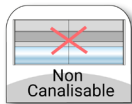
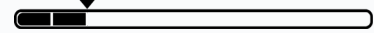

**LONGUEURS DISPONIBLES** 1500 / 2000 / 2500 / 3000 / 3500 mm

## PARE-CHOCS

NOIR



GRIS



AZUR



## DESCRIPTIF STANDARD

Décor de façade et pieds en inox AISI 304  
 Joue de finition ép. 40 mm, grise  
 Pare-chocs Gris ou Noir ou Azur  
 Toutes pièces d'exposition en inox AISI 316  
 Tablette de travail 320 mm en granit Rosa Beta  
 Vitrage bombé fixe  
 Sans éclairage  
 Bac plastique de récupération des eaux de dégivrage. Vidange manuelle  
 Superstructure vitrée à monter

## CARACTÉRISTIQUES TECHNIQUES

Température 0 / +2°C classe 3M1 ou +2 / +4 °C classe 3M2  
 Thermomètre mécanique

### INFORMATIONS

Adapté à l'exposition de Viandes ou Fromages

SAIGON FROID STATIQUE					
Modèles	Longueur [mm]		Puissance Watts à -10°C	Groupe logé	Sans groupe
	Avec joues	Sans joues		Code	Code
1500	1500	1420	355	SAIG01	SAIG11
2000	2000	1920	480	SAIG02	SAIG12
2500	2500	2420	605	SAIG03	SAIG13
3000	3000	2920	730	SAIG04	SAIG14
3500	3500	3420	855	SAIG05	SAIG15

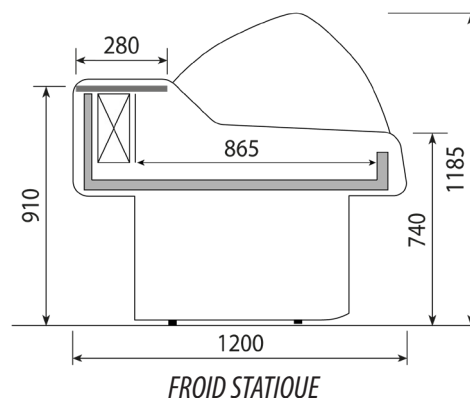

## OPTIONS ET ACCESSOIRES

Accessoires SAIGON	Code
Caisse 700 mm avec joues et tiroir <b>1</b>	SAIG021
Caisse 1000 mm avec joues et tiroir <b>1</b>	SAIG022
Séparation mobile basse en verre	SAIG051



Options par longueur SAIGON	1500	2000	2500	3000	3500
	Code	Code	Code	Code	Code
Plexiglas arrière coulissants	SAIG210	SAIG211	SAIG212	SAIG213	SAIG214
Plan de travail en inox AISI 304	SAIG610	SAIG611	SAIG612	SAIG613	SAIG614
Chassis avec 4 roulettes	SAIG245	SAIG246	SAIG247	x	x
Libre-service, glace basse (-value) <b>2</b>	SAIG900	SAIG901	SAIG902	SAIG903	SAIG904

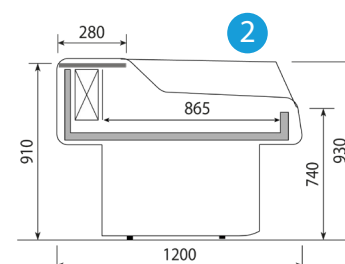
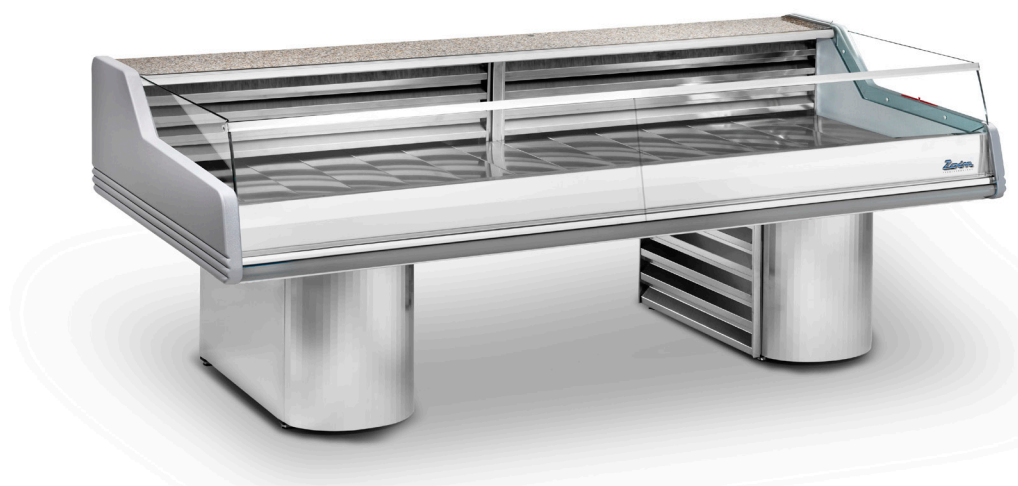

**LIBRE SERVICE  
GLACE BASSE**



Longueur spéciale sur demande



Froid statique

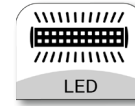

Éclairage LED

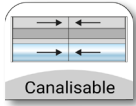

Meuble canalisable

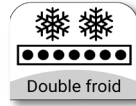

Double froid



Bain-Marie

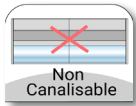

Meuble non canalisable



Gaz R... Groupe logé

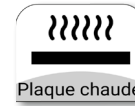

Plaque chaude

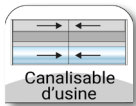

Meuble canalisable d'usine

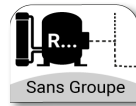

Gaz R... Groupe à distance

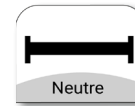

Neutre



Avec réserve réfrigérée



Dégivrage naturel



Régulation électronique avec affichage digital



Avec ou sans réserve réfrigérée



Dégivrage manuel



Régulation électronique avec thermomètre mécanique



Ventilation frontale anti-buée



Dégivrage électrique



Régulation mécanique avec thermomètre mécanique



Cuve intérieur inox AISI ...



Dégivrage gaz chaud



Contrôle de l'hygrométrie



Classification au feu Bs3d0

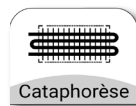

Évaporateur cataphorèse

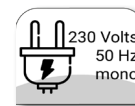

Alimentation 230 Volts / 50Hz / Mono



Froid ventilé



Évaporation automatique des condensats

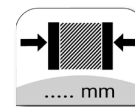

Épaisseur isolation ...mm



Froid ventilé avec vitesse de ventilation réglable



Sans évaporation des condensats

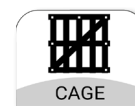

Cage bois